



Design: F. Trabucco & Associates



VORT QUADRO RANGE

Centrifugal duct fans

Centrifugal fans for wall or ceiling installation, designed for the ventilation of residential and commercial premises whose layout requires ducting of the exhaust. The elegant front panel which hides the hole behind it reduces the aesthetic impact of the installed product.

Key features

- Closed front panel that confers a modern image to the product and facilitates its cleaning.
- Reduced exhaust sleeve depth, compatible with installation immediately upstream of a 90° bend.
- Decentralised exhaust which, with the 360° adjustable front panel, amplifies the range of possible installations
- 2 or 3-speed motors for the best balance between performance, consumption and sound emissions.
- High protection from water, suitable for use in Zone 1 bathroom installations and in the presence of high relative humidity.

Version

6 models, different in size, performance and supply, also available in versions with timer and relative humidity sensor.

Technical features

- White, shock-proof, plastic resin (ABS) casings prevent ageing caused by exposure to sunlight ("UV resistant").
- 3-speed fan motors, obtained from the combination of:
 - Heat protected motors with shafts mounted on ball bearings to guarantee long lasting continuous service (at least 30,000 h) at the maximum plate temperature. Speed adjustment using Vortice accessory devices.
 - Forward-curved centrifugal impellers moulded in plastic resin, resistant to aggressive agents.
- 3-position speed selector, including ON/ OFF command, compatible with wall and recessed box installation as per standard UNI 503.
- Dishwasher-safe air filters in PU.
- Non-return valves integrated on the exhaust ducts to prevent unwanted inflows of air and bad odours when the appliance is switched off.
- T models equipped with electronic timer for automatic product switch-off after a pre-fixed period of time, which can be set in the installation phase, from 3'-20' (default setting 3').
- T-HCS models equipped with circuit board with relative humidity sensor (RH), adjustable to 4 predefined threshold levels (60%, 70%, 80%, 90 %), alternatively can be set during installation, which determines automatic fan activation. The board integrates an electronic timer for automatic shut-down of the product after return to a RH below the pre-set threshold. The duration of the timer can be set at installation within the interval 3'-20' (default setting 3').
- Performance and safety certified by third party body (IMQ)
- Class of electric isolation: II □ (earthing not required).



RANGE

	BASE	TIMER	TIMER HCS
MICRO 80	11638 MICRO 80	11648 MICRO 80 T	-
MICRO 100	11936 MICRO 100 11937 MICRO 100 ES	11940 MICRO 100 T 11941 MICRO 100 T ES	11945 MICRO 100 THCS
MEDIO	11944 MEDIO	11946 MEDIO T	11975 MEDIO THCS
SUPER	11952 SUPER	11954 SUPER T	11989 SUPER THCS



TECHNICAL DATA

MODELS	V~50HZ	W min/max	A min/max	RPM min/max	MAX AIRFLOW		MAX PRESSURE		Lp dB(A) 3m min/max	MAX °C	KG
					m ³ /h min/max	l/s min/max	mmH ₂ O min/max	Pa min/max			
MICRO 80	220-240	19 27	0.10 0.13	1150 1580	60 85	17 24	22 27	216 265	28.7 37.0	50	1.79
MICRO 100	220-240	20 28	0.10 0.13	1180 1600	65 90	18 25	16 22	157 216	32.3 39.2	50	1.80
MICRO 100 ES	220 - 240	8 15	0,08 0,12	1235 1630	65 90	18 25	9 18	88 177	34,5 37,4	50	1,80
MEDIO	220-240	25 29	0.14 0.18	1150 1890	70 120	19 33	22 34	216 329	36,7 43,4	50	2.50
SUPER	220-240	50 105	0.36 0.50	1400 2200	140 280	38 77	23 50	226 490	41.9 48.6	50	3.77



RESIDENTIAL VENTILATION

VORT QUADRO RANGE

VORT QUADRO RANGE | TECHNICAL DATA FOR REGULATION N° 1254/2014/UE

	UNIT OF MEASURE	MICRO 80	MICRO 100	MEDIO
Supplier's name or trade mark	-	Vortice	Vortice	Vortice
Specific Energy Consumption class SEC in average climate zone	-	NA	NA	NA
Specific Energy Consumption class SEC average	-	-0,5	0,0	0
Specific Energy Consumption class SEC cold	kWh/m ² year	-13,9	-13,3	-14
Specific Energy Consumption class SEC warm	-	7,2	7,7	7
Declared typology	-	RVU-U**	RVU-U**	RVU-U**
Type of drive	-	NA	NA	VSD****
Type of heat recovery system HRS	-	none	none	none
Thermal efficiency of heat recovery at reference air flow	%	NA	NA	NA
Maximum flow rate	m ³ /h	95	92	103
Electric power input of the fan drive, including any motor control equipment, at maximum flow rate	W	28,7	28,1	29,4
Sound power level LWA	LWA [DB(A)]	58	60	64
Reference flow rate	m ³ /s	0,0185	0,0179	0,0286
Reference pressure difference	Pa	148	196	141
SPI	W/(m ³ /h)	0,39098	0,40683	0,398
Control factor CTRL	-	1	1	1
Control typology	-	manual	manual	manual
Maximum internal leakage rates	%	NA	NA	NA
Maximum external leakage rates	%	NA	NA	NA
Mixing rate	-	NA	NA	NA
Position and description of visual filter warning	-	NA	NA	NA
Airflow sensitivity to pressure variations at + 20 Pa and - 20 Pa	-	NA	NA	0,10
Indoor/outdoor air tightness	m ³ /h	NA	NA	NA
Annual electricity consumption (AEC)	kWh electricity/year	539	561	549
AHS average Annual heating saved	-	1397	1397	1397
AHS cold Annual heating saved	kWh primary energy/year	2732	2732	2732
AHS warm Annual heating saved	-	632	632	632

* RVU-U: Unit Ventilation Residential - Unidirectional - **NRVU-U: Unit Ventilation Non Residential - Unidirectional - ***MSD: Multi-Speed Drive - ****VSD: Variable-Speed Drive - NA: Not applicable

VORT QUADRO RANGE | TECHNICAL DATA FOR REGULATION N° 1254/2014/UE

	UNIT OF MEASURE	SUPER
Supplier's name or trade mark	-	Vortice
Declared typology	-	NRVU-U**
Type of drive	-	VSD***
Type of heat recovery system HRS	-	None
Thermal efficiency of heat recovery	-	NA
Nominal NRVU flow rate	m ³ /s	0,05556
Effective electric power input	kW	0,090
SFPint	W/(m ³ /h)	NA
Face velocity at design flow rate	m/s	7,528
Nominal external pressure (Δps,int)	Pa	200
Internal pressure drop of ventilation components (Δps,int)	Pa	245
Internal pressure drop of non-ventilation components (Δps,int)	Pa	0
Static efficiency of fans used in accordance with Regulation (EU) N. 3272011	%	27,5
Declared maximum internal leakage rate of the casing of ventilation units	%	NA
Declared maximum external leakage rate of the casing of ventilation units	%	4,2
Energy performance energy or classification of the filters	-	NA
Description of visual filter warning	%	NA
Casing sound power level (LWA)	dB(A)	69

* RVU-U: Unit Ventilation Residential - Unidirectional - **NRVU-U: Unit Ventilation Non Residential - Unidirectional - ***VSD: Variable-Speed Drive



DIMENSIONS

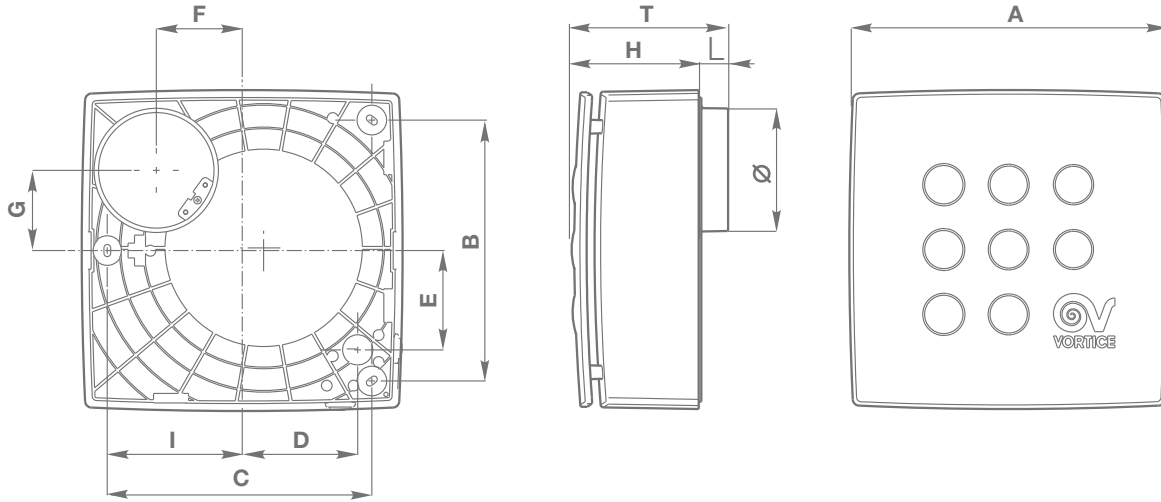

MODELS	∅A	B	C	D	E	F	G	H	I	L	T	∅
MICRO 80	239	195	197	85	74	64	60	97	100	20	117	73.5
MICRO 100	239	195	197	85	74	64	60	97	100	20	117	92.5/97

Dimensions (mm)

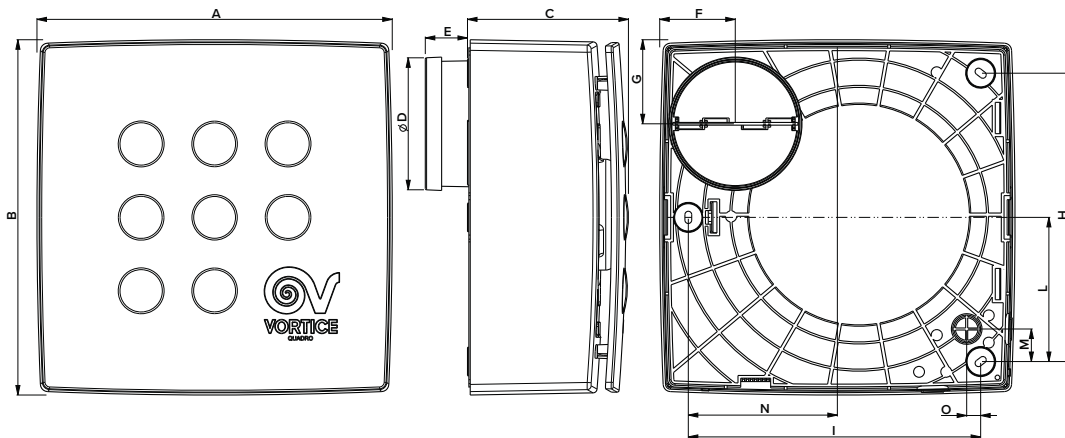

MODELS	∅A	B	C	D	E	F	G	H	I	L	M	N	O
MEDIO	261	261	119	97	31	55,5	62	212	215	106	24	110	10
SUPER	290	290	144	97	31	58	64	236	239	118	26	125	6,5

Dimensions (mm)



RESIDENTIAL VENTILATION

VORT QUADRO RANGE

PERFORMANCE CURVES

MICRO 80

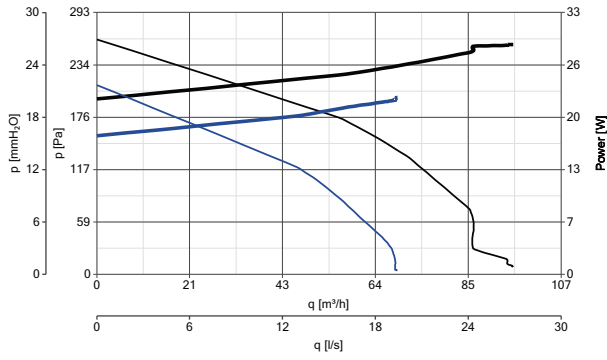

MICRO 100

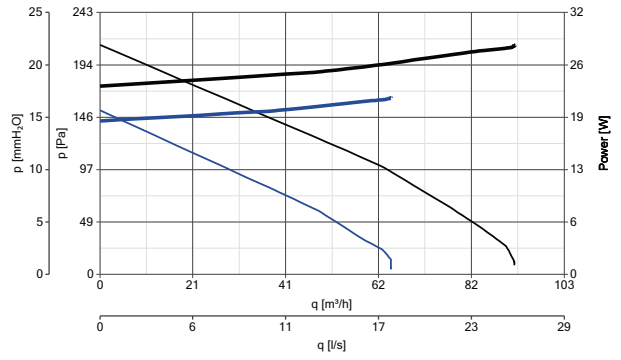

MICRO 100 ES

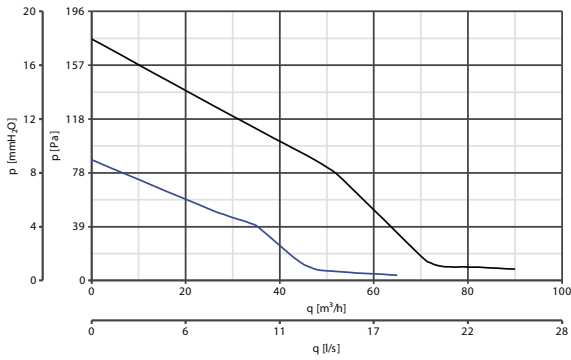

PERFORMANCE CURVES POWER CONSUMPTION
 — max — max
 — min — min

MEDIO

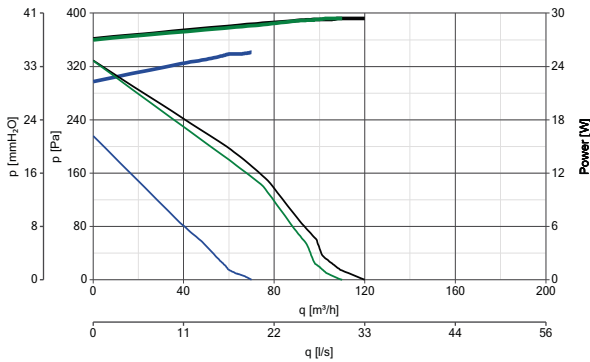

PERFORMANCE CURVES POWER CONSUMPTION
 — Speed 1 — Speed 1
 — Speed 2 — Speed 2
 — Speed 3 — Speed 3

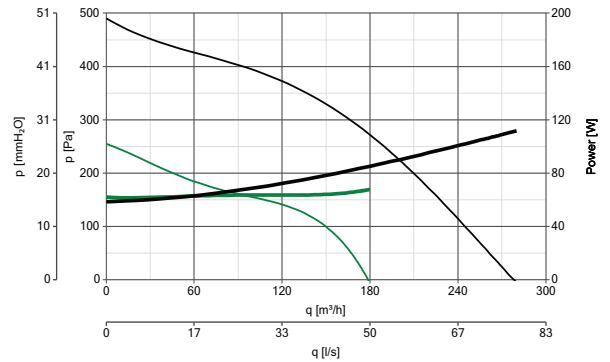

SUPER



PERFORMANCE CURVES POWER CONSUMPTION
 — min — min
 — max — max



CONTROLLER

MODELS	DESCRIPTION	CODE	PRODUCT
	C 1.5 - Electronic speed controller 1.5 A	12966	ALL PRODUCTS
	SCB KIT - Built-in controller adaptor for C 1.5	22481	12966
	TRIO-S - Built-in controller adaptor for C 1.5	12871	11952 - 11954 - 11989

ACCESSORIES ON REQUEST

MODELS	DESCRIPTION	CODE	PRODUCT
	AIR DEFLECTOR	100/4 22310	ALL PRODUCTS

APPLICATIONS





Design: F. Trabucco & Associates



VORT QUADRO I RANGE

Centrifugal duct fans for flush mounting

2-3 speed centrifugal duct fans for recessed installation in correspondence with walls and ceilings, designed for ventilation of residential and commercial premises whose layout requires ducting of the exhaust. The elegant front panel which hides the hole behind it reduces the aesthetic impact of the installed product. Standard supplied equipment includes a speed selector.

Key features

- Closed front panel that confers a modern image to the product and facilitates its cleaning.
- Possibility of rear or side ducting.
- Possibility of connection to a second duct for additional ventilation of an adjacent room.
- 2 or 3 speed fan motors for an ideal compromise between performance, consumption and sound emissions.
- High protection from water, suitable for use in Zone 1 bathroom installations and in the presence of high relative humidity.
- Non-return valves to prevent unwanted inflows of cold air and bad odours when the appliance is switched off.

Version

6 models, different in size, performance and supply, also available in versions with timer and relative humidity sensor.

Technical features

- White, shock-proof, plastic resin (ABS) casings prevent ageing caused by exposure to sunlight ("UV resistant").
- Recessed boxes in black plastic resin (PP), loaded to give suitable resistance to the parts to be walled, rear exhaust, pre-set for side exhaust.
- 3-speed fan motors, obtained from the combination of:
 - Heat protected motors with shafts mounted on ball bearings to guarantee long lasting continuous service (at least 30,000 h) at the maximum plate temperature. Speed adjustment using Vortice accessory devices.
 - Forward-curved centrifugal impellers moulded in plastic resin, resistant to aggressive agents.
- 3-position speed selector, including ON/OFF command, compatible with wall and recessed box installation as per standard UNI 503.
- Dishwasher-safe air filters in PU.
- Non-return valves integrated on the exhaust ducts to prevent unwanted inflows of air and bad odours when the appliance is switched off.
- T models equipped with electronic timer for automatic product switch-off after a pre-fixed period of time, which can be set in the installation phase, from 3'-20' (default setting 3').
- T-HCS models equipped with circuit board with relative humidity sensor (RH), adjustable to 4 predefined threshold levels (60%, 70%, 80%, 90 %), alternatively can be set during installation, which determines automatic fan activation. The board integrates an electronic timer for automatic shut-down of the product after return to a RH below the pre-set threshold. The duration of the timer can be set at installation within the interval 3'-20' (default setting 3').
- Performance and safety certified by third party body (IMQ)
- Class of electric isolation: II □ (earthing not required).



RANGE

	BASE	TIMER	TIMER HCS
MICRO 100 I	12017 MICRO 100 I 12045 MICRO 100 I ES	12018 MICRO 100 I T 12046 MICRO 100 I T ES	12065 MICRO 100 I T HCS
MEDIO I	12020 MEDIO I	12021 MEDIO I T	12066 MEDIO I T HCS
SUPER I	12023 SUPER I	12024 SUPER I T	12067 SUPER I T HCS



TECHNICAL DATA

MODELS	V~50HZ	W min/max	A min/max	RPM min/max	MAX AIRFLOW		MAX PRESSURE		Lp dB(A) 3m min/max	MAX °C	KG
					m³/h min/max	l/s min/max	mmH₂O min/max	Pa min/max			
MICRO 100 I	220-240	20 27	0,10 0,12	1010 1450	75 100	21 28	20 22	196 218	26,3 34,3	50	1,91
MICRO 100 I ES	220-240	8 15	0,08 0,12	1090 1430	75 100	21 28	9 18	88 177	31,8 38,4	50	1,91
MEDIO I	220-240	25 29	0,14 0,18	1150 1890	70 122	19 34	21 34	206 331	35,9 41,2	50	2,8
SUPER I	220-240	50 115	0,36 0,50	1280 2190	140 285	38 79	20 48	196 476	33,6 46,7	50	4,27



RESIDENTIAL VENTILATION

VORT QUADRO I RANGE

VORT QUADRO I RANGE | TECHNICAL DATA FOR REGULATION N° 1254/2014/UE

	UNIT OF MEASURE	MICRO 100 I	MEDIO I
Supplier's name or trade mark	-	Vortice	Vortice
Specific Energy Consumption class SEC in average climate zone	-	NA	NA
Specific Energy Consumption class SEC average	-	-15,0	-14
Specific Energy Consumption class SEC cold	kWh/m ² year	-1,7	-1
Specific Energy Consumption class SEC warm	-	6,0	7
Declared typology	-	RVU-U*	RVU-U*
Type of drive	-	NA	MSD
Type of heat recovery system HRS	-	none	none
Thermal efficiency of heat recovery at reference air flow	%	NA	NA
Maximum flow rate	m ³ /h	100	106
Electric power input of the fan drive, including any motor control equipment, at maximum flow rate	W	27,0	29,6
Sound power level LWA	LWA [DB(A)]	54	62
Reference flow rate	m ³ /s	0,0194	0.02944
Reference pressure difference	Pa	95	196
SPI	W/(m ³ /h)	0.35714	0.384
Control factor CTRL	-	1	1
Control typology	-	manual	manual
Maximum internal leakage rates	%	NA	NA
Maximum external leakage rates	%	NA	NA
Mixing rate	-	NA	NA
Position and description of visual filter warning	-	NA	NA
Airflow sensitivity to pressure variations at + 20 Pa and – 20 Pa	-	NA	0,06
Indoor/outdoor air tightness	m ³ /h	NA	NA
Annual electricity consumption (AEC)	kWh electricity/year	492	529
AHS average Annual heating saved	-	1397	1397
AHS cold Annual heating saved	kWh primary energy/year	2732	2732
AHS warm Annual heating saved	-	632	632

* RVU-U: Unit Ventilation Residential - Unidirectional - **NRVU-U: Unit Ventilation Non Residential - Unidirectional - ***MSD: Multi-Speed Drive - NA: Not applicable

VORT QUADRO I AC RANGE | TECHNICAL DATA FOR REGULATION N° 1254/2014/UE

	UNIT OF MEASURE	SUPER I
Supplier's name or trade mark	-	Vortice
Declared typology	-	NRVU-U**
Type of drive	-	VSD***
Type of heat recovery system HRS	-	None
Thermal efficiency of heat recovery	-	NA
Nominal NRVU flow rate	m ³ /s	0,05833
Effective electric power input	kW	0,095
SFPint	W/(m ³ /h)	NA
Face velocity at design flow rate	m/s	7,894
Nominal external pressure (Δps,int)	Pa	205
Internal pressure drop of ventilation components (Δps,int)	Pa	245
Internal pressure drop of non-ventilation components (Δps,int)	Pa	0
Static efficiency of fans used in accordance with Regulation (EU) N. 3272011	%	27,6
Declared maximum internal leakage rate of the casing of ventilation units	%	NA
Declared maximum external leakage rate of the casing of ventilation units	%	NA
Energy performance energy or classification of the filters	-	NA
Description of visual filter warning	%	NA
Casing sound power level (LWA)	dB(A)	67

* RVU-U: Unit Ventilation Residential - Unidirectional - **NRVU-U: Unit Ventilation Non Residential - Unidirectional - ***VSD: Variable-Speed Drive



DIMENSIONS

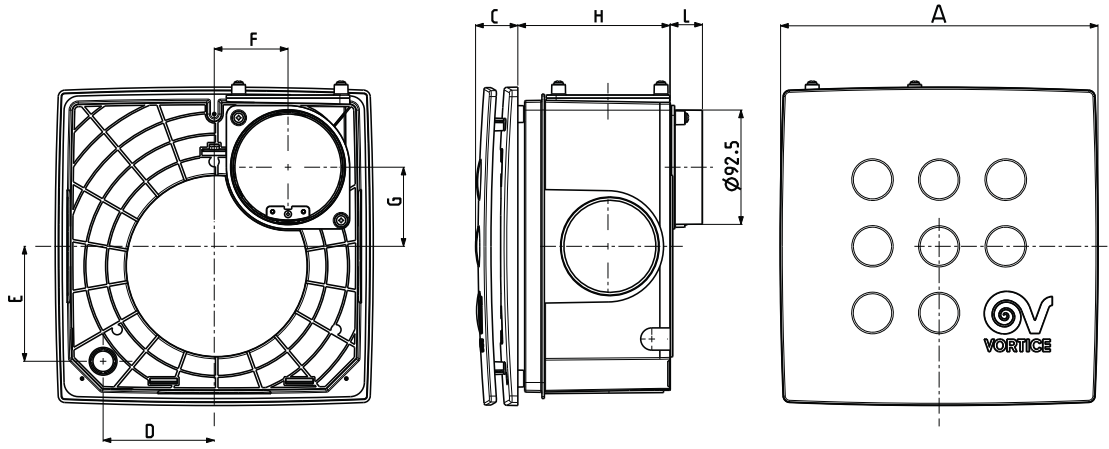

MODELS	A	C	D	E	F	G	H	L
MICRO 100 I	258	34	92	90	64	60	118	26
MICRO 100 I ES	258	34	92	90	64	60	118	26
MEDIO I	287	37	97	103	72	69	130	26

Dimensions (mm)

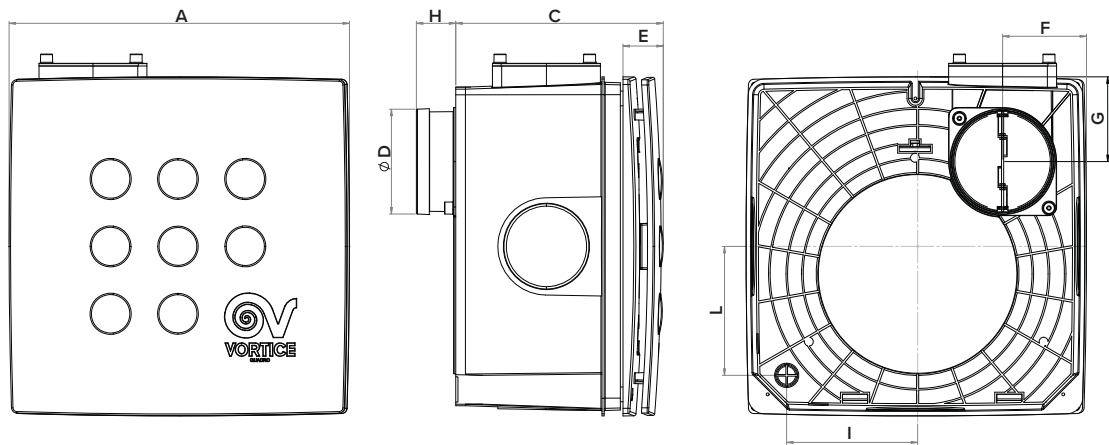

MODELS	A	C	D	E	F	G	H	I	L
SUPER	314	190	97	37	76	79	37	120	120

Dimensions (mm)



PERFORMANCE CURVES

MICRO 100 I

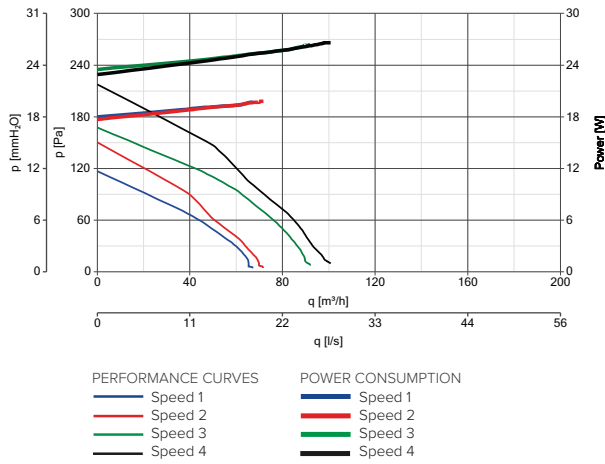

MICRO 100 I ES

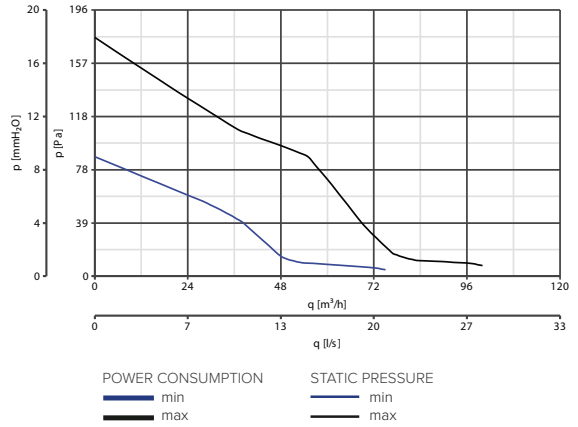

MEDIO I

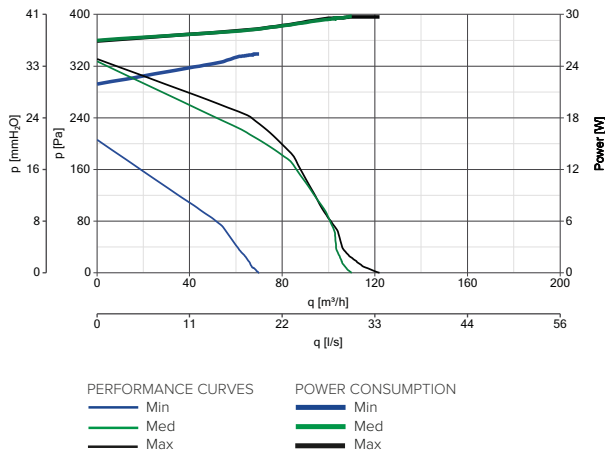



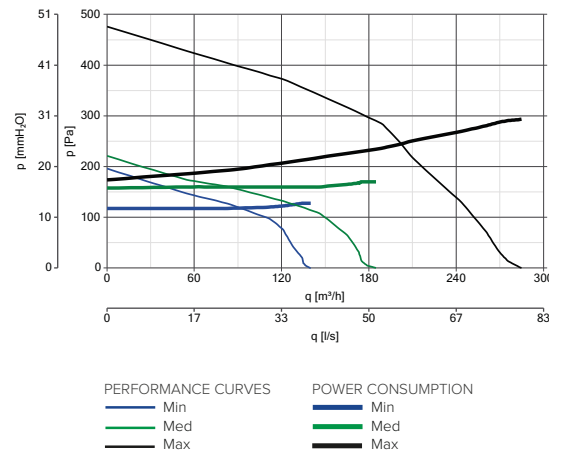

SUPER I







CONTROLLER

MODELS	DESCRIPTION	CODE	PRODUCT
	C 1.5 - RElectronic speed controller 1.5 A	12966	ALL PRODUCTS
	SCNRB - Electronic speed controller built-in	12971	ALL PRODUCTS
	SCB KIT - Built-in controller adaptor for C 1.5	22481	12966
	TRIO-S - Bult-in controller adaptor for C 1.5	12871	12023 - 12024 -12067

ACCESSORIES ON REQUEST

MODELS	DESCRIPTION	CODE	PRODUCT
	AIR DEFLECTOR	100/4 22310	ALL PRODUCTS
	CEILING KIT	MICRO 100 I 22491	12017 - 12045 - 12018 - 12046 - 12065
		MEDIO I 22492	12020 - 12021 - 12066
		SUPER I 22493	12023 - 12024 - 12067

APPLICATIONS



Predstavništvo za Srbiju
AIRTREND Ltd.
Kumanovska 14
11000 Beograd, Srbija
Telefon +381 (0)11 383 6886, 308 5740
Telefax +381 (0)11 344 4113
E-mail gobrid@eunet.rs
www.airtrend.rs

Distribucija i prodaja
KOVENT
Kumanovska 14
Tel: 011 383 6886, 308 5740
Fax: 011 344 4113
E-mail office@kovent.rs
www.kovent.rs

